

TECHNICAL REPORT 1

University Academic Center

Eastern USA



Alexander Altemose

Structural Option

Advisor: Thomas E. Boothby

September 17, 2012

Table of Contents

| | |
|-----------------------------|----|
| Executive Summary | 3 |
| Introduction | 5 |
| Structural Overview | 6 |
| Foundation | 7 |
| Floor and Roof System | 9 |
| Framing System | 10 |
| Lateral System | 11 |
| Design Codes | 12 |
| Design Loads | 13 |
| Dead Loads | 13 |
| Live Loads | 13 |
| Snow Loads | 15 |
| Seismic Loads | 17 |
| Wind Loads | 18 |
| Spot Checks | 20 |
| Slab Check | 20 |
| Beam Check | 21 |
| Column Check | 21 |
| Conclusion | 22 |
| Appendix | 23 |

Executive Summary

The goal of this report is to gain an understanding of the structural systems utilized in the construction of the University Academic Center, located in eastern United States. This was accomplished through analysis of these systems with current codes and standards including ASCE7-10, IBC 2009, the 14th Edition AISC Steel Manual, and Vulcraft steel deck catalog.

An overview of the building systems is first presented to establish a base of understanding into the design of the University Academic Center. This includes an overall building description, followed by foundation, floor and roofing, framing, and lateral system details and images. Analysis is then done for various loading scenarios to compare with actual building design. Codes used in both the design of the University Academic Center as indicated on the plans and used in this report for analysis purposes are listed on page 12. Minor differences in calculated values and those provided in plans will be accredited to the code differences if any.

Dead loads and live loads were determined using ASCE7-10 and compared to those used in the actual design as indicated in plan. The larger of these two sets of numbers would be the basis of all values in further calculations.

An analysis of snow loads was calculated along with a preliminary drift analysis at several areas of potential drift. The results of this exercise show the designer's use of 20 psf flat roof snow load to be greater than the calculated 15.75 psf and therefore safe for snow. However, during snow drift analysis a maximum drift load of 62.71 psf at location 11 as indicated on page 13 is cause for concern and requires a more detailed inspection.

Seismic analysis done using ASCE7-10 required an estimate of building self weight be determined. This was then used to calculate a base shear of 377 kips and an overturning moment of 17,892 kip-ft. These values compared well with the base shear value of 363 kips given on the plans as designed with a difference of only 4%.

The MWFRS Directional Procedure was used for wind analysis as found in ASCE7-10. A simplified building shape was chosen based on elevation profiles from the plans. This resulted in a base shear of 1013.7 kips and an overturning moment of 87,357.2 kip-ft. These values are assumed higher than actual values due to the fact that most walls are rotated on angles and would not see the full effects of wind forces simultaneously.

Several spot checks were done to verify the sizes of members used in the University Academic Center under gravity loadings. These include a slab check for deck type specification, a composite beam used to support said deck, and a ground floor column supporting a typical bay. The slab was determined to be adequate to support the typical classroom loading of 40 psf specified as 3 1/4" LWC with 6"x6", W1.4xW1.4 WWF on 2" - 18 gage decking. This comparison was made to 2VLI18 deck capabilities found in the Vulcraft deck catalog. Design of the beam showed it to be partially composite with the limiting factor being the shear capacity determined by shear studs of 464.4 kips. Values for size determination were taken from the AISC steel manual this along with deflection checks showed the beams to be safe as designed. Finally a column check was done which resulted in an acceptably sized column after live load reduction was implemented.

Introduction

Located in the eastern United State and placed in a quiet suburban setting, the University Academic Center is a 192,000 square foot building designed to house a library resource center, dining area, 45 classrooms, and over 120 offices. Other key features include a 5-story atrium and multiple roof gardens.

The layout of the building consists three main sections. The northern 3-story section contains of mostly dining and classroom areas. In the center of the building, a 4 story section houses the library and the majority of classrooms, as well as acting as the main entrance. The southern end of the building consists almost entirely of office

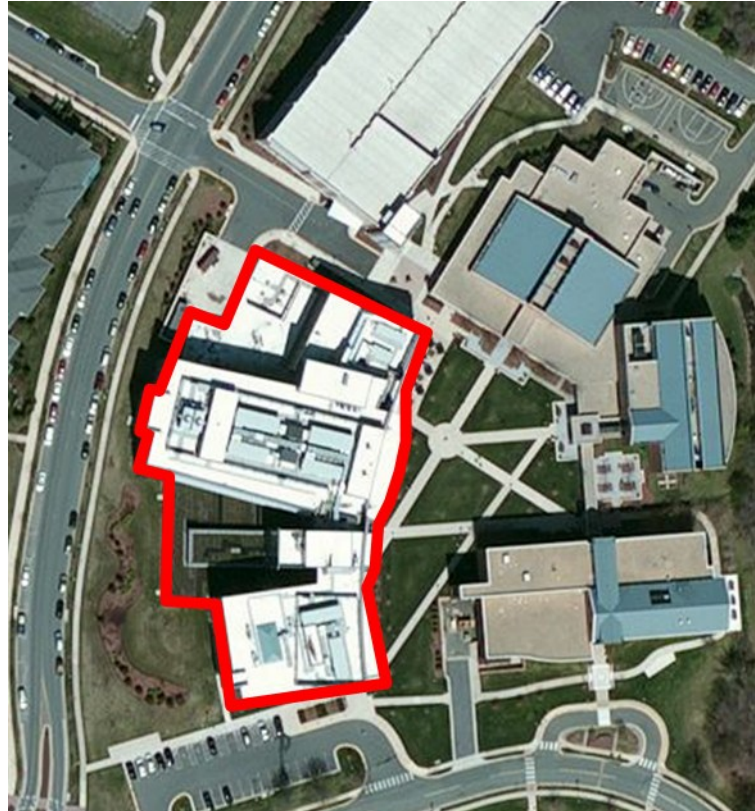

Photo taken from Bing Maps

spaces. Between the 4 and 5-story sections of the building is the main vertical circulation for the building. This space also provides access to the roof garden.

There are 4 main types of building façade implemented in this building. The 3 and 5-story sections of the building have a brick façade with cast stone bands running horizontally across the brick surface. Glass curtain walls are used in the vertical circulation located on either side of

the 4-story section. The 4-story section's façade is mostly metal panels. There is also glazed CMU used to accent the other façade types at various places.

Through the use of multiple energy saving techniques the University Academic Center holds a LEED gold rating. This includes site design to minimize storm water runoff and the use of recyclable and local materials. Energy efficient HVAC equipment and the use of natural day lighting as well as shading devices also help minimize energy consumption. All these features, along with the roof gardens, provide a "green" learning environment.

Structural Overview

The University Academic Center is a steel framed building with composite metal decking all sitting atop a foundation of spread footings and slab-on-grade. The building is supported from lateral forces by a combination of braced and moment frames. In the case of gravity loads, the floor and roof systems will take the force from dead and live loading and distribute it to beams and girders. These loads are then transferred into the columns which then transfer the loads into the foundation and ultimately into the earth. In the case of lateral loading, forces work to overturn the building. Wind forces are taken by the façade into beams and girders. These forces must meet some resistance in the form of lateral bracing via braced or moment connections otherwise the forces will cause failure when they reach the columns. Similarly, seismic forces will cause lateral movement of the earth beneath the building and if connections are not properly braced failure will occur.

Foundation

Based on the 2002 geotechnical report taken, footings for University Academic Center are designed for an allowable bearing capacity of 3000 psf. Footings are placed on undisturbed soil or on structurally compacted fill. The bottom of exterior footings shall be 2'-6" below grade.

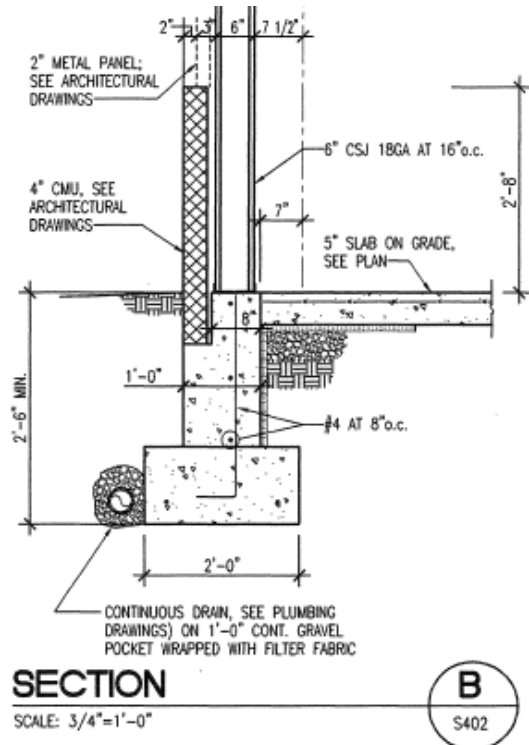

Drawings provided by Skanska

Slab-on-grade sits on a coarse granular fill material compacted to 95% of maximum density as defined by ASTM D1557 modified proctor test. The slab-on-grade is designed as 5" thick concrete reinforced with 6"x6", W1.4xW1.4 WWF.

This encompasses all slab-on-grade except for the area located under the library stacks which is 6" thick concrete reinforced with 2 layers of 6"x6", W2.1xW2.1 WWF.

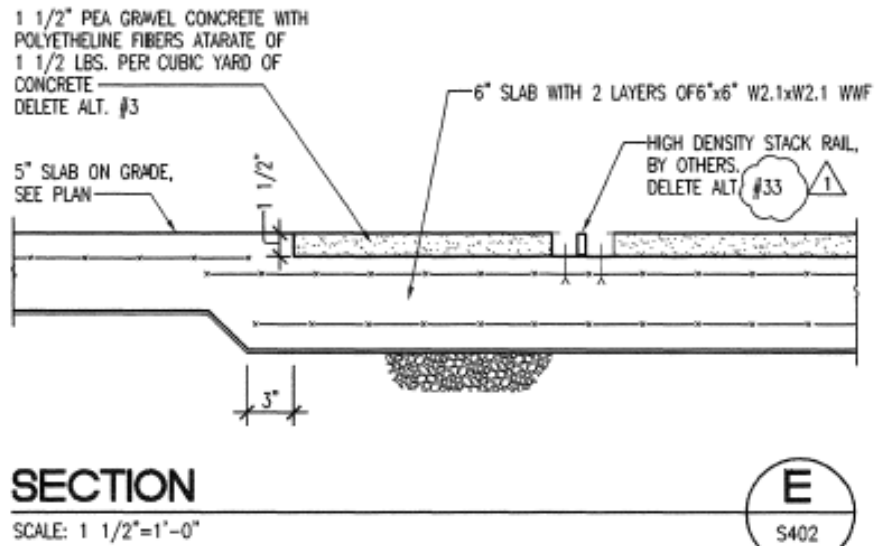

Drawings provided by Skanska

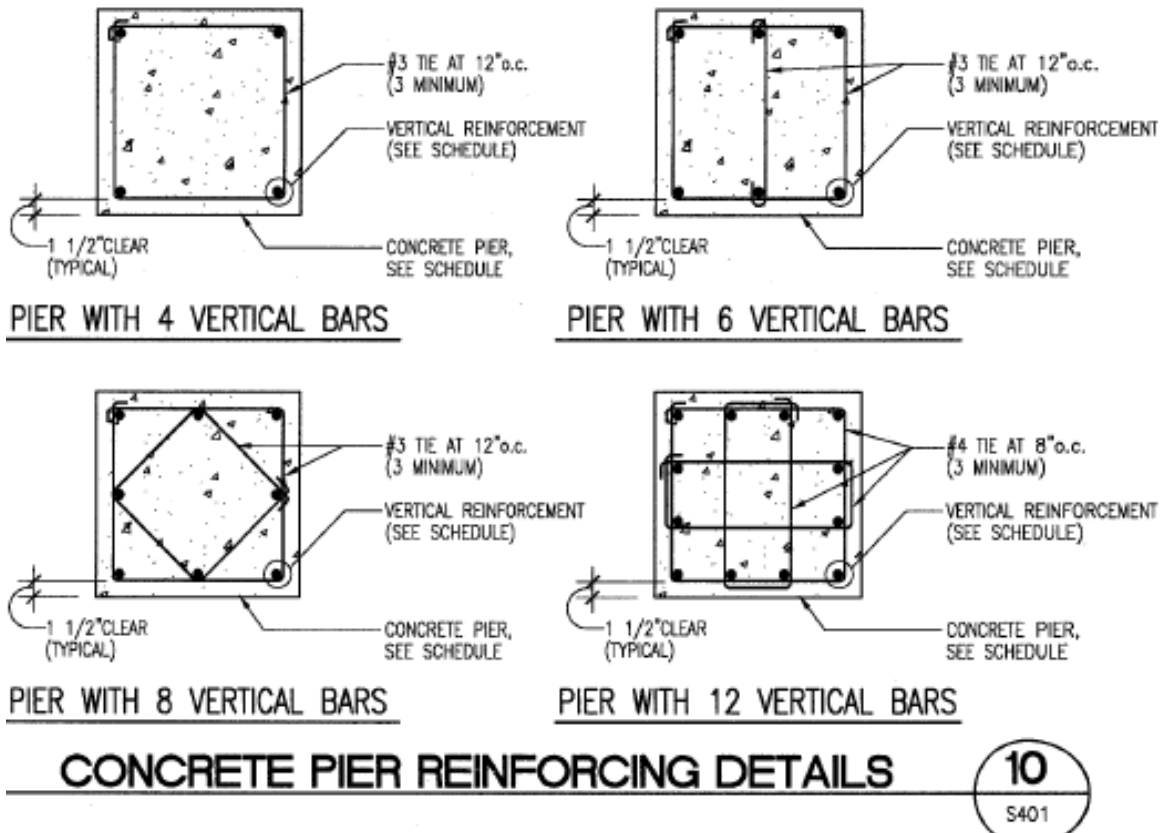

Drawings provided by Skanska

The columns in the University Academic Center rest on piers and footings ranging in size depending on loading and connection type. The columns are embedded 8" in concrete then anchored to a base plate which rests on the pier. These piers are a minimum of 8" ranging to a maximum depth of 3'-9". The piers come in 4 types: 4, 6, 8, and 12 vertical bar piers. Footings also range in size under the columns with a maximum 19'x19' under a single column.

Floor and Roof Systems

The University Academic Center utilizes a composite metal deck flooring system. This includes 2" composite 20 gage deck with ribs 12" o.c. and 1.5" type B, wide rib 20 gage deck. All metal deck is designed to be continuous over 3 spans. Floor system also includes shear studs and lightweight concrete topping varying based on location and loading.

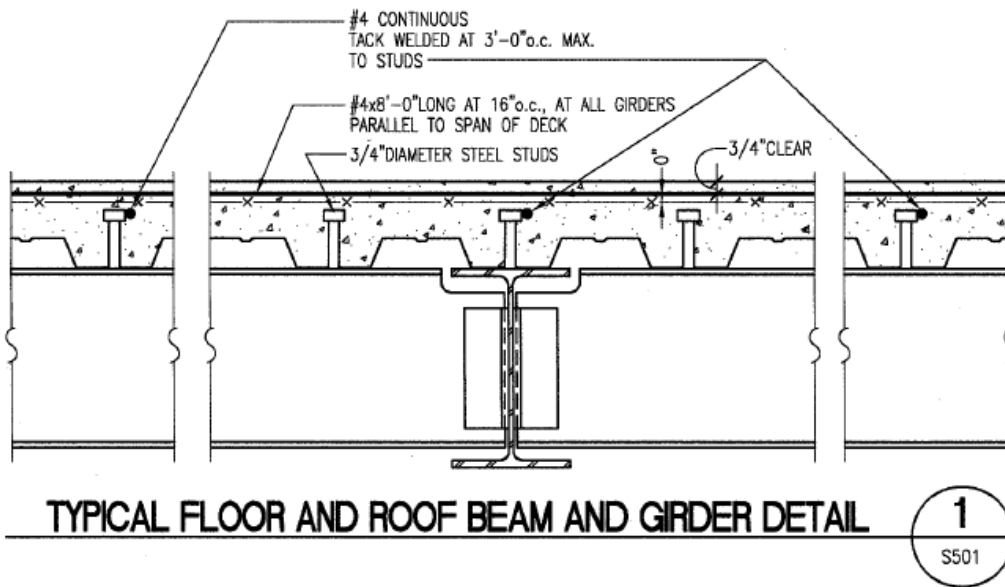

Drawings provided by Skanska

Roofing systems also varies due to some areas like the roof gardens and mechanical areas of greater loading. Decking for roofs includes both 2" composite 18 gage deck with ribs 12" o.c. and 1.5" type B, wide rib 20 gage deck.

Framing System

The framing system for the University Academic Center is complex and varies greatly due to the differing roof heights and use of spaces. Steel members used throughout the building include C-shapes, HSS members, and Wide Flange members with the majority being W-shapes.

Gridlines are set at multiple angles and bay sizes vary throughout the building. The only areas with a typical framing are those located in the classroom areas in the central section of the building and the office spaces on the south side.

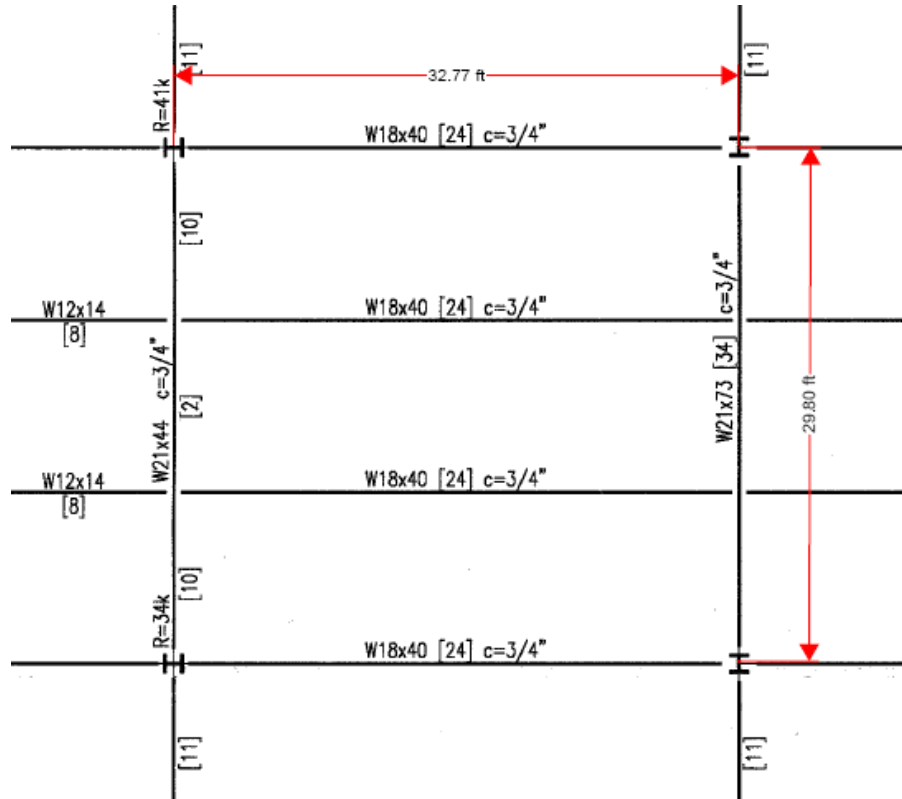

Drawings provided by Skanska

Lateral System

The lateral system for this building is also complex with braced frames of varying heights and styles located throughout the building. To the right is a plan view of University Academic Center with the 15 lateral braced frames shown in blue. Elevations of each frame can be found in the Appendix.

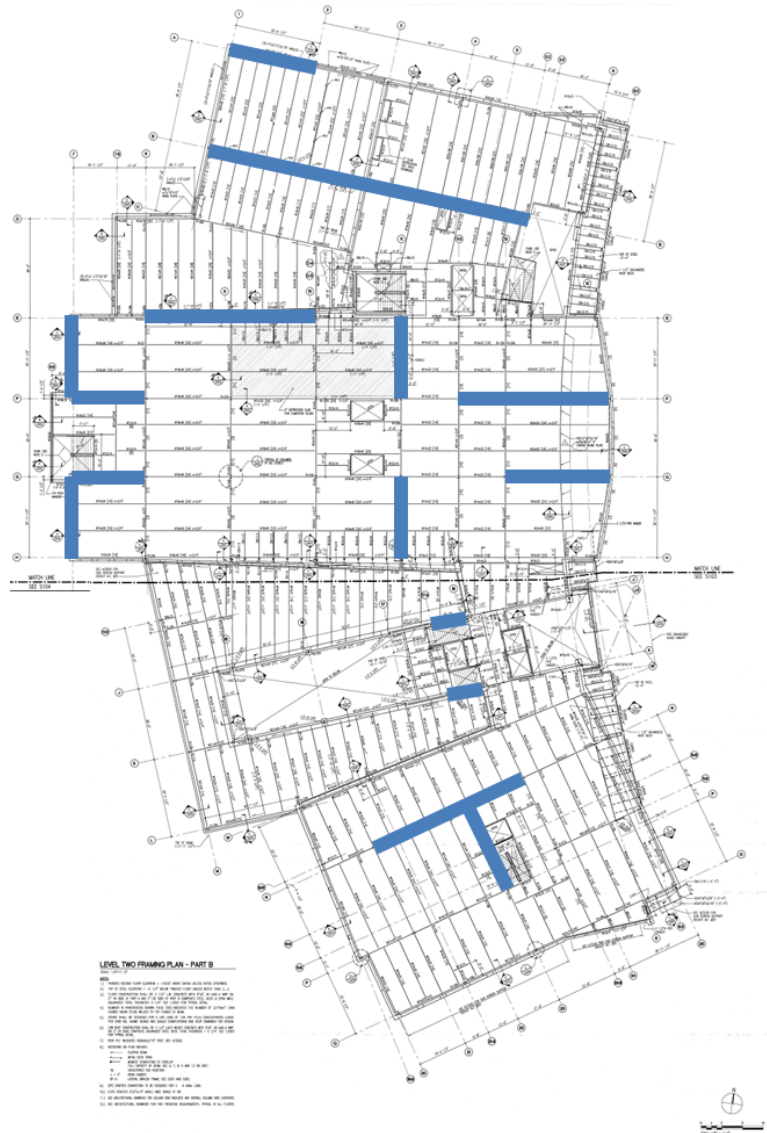

Drawings provided by Skanska

Design Codes

As Designed:

- 2000 ICC International Building Code
- 2000 ICC International Mechanical Code
- 2000 ICC International Plumbing Code
- 2000 ICC International Fuel-Gas Code
- 2000 ICC International Fire Code
- 2000 ICC International Energy Conservation Code
- 2000 NFPA Life Safety Code
- 2000 Americans with Disabilities Act – Accessibility Code
- 1999 National Electrical Code

Thesis Calculations:

- 2009 International Building Code
- American Society of Civil Engineers (ASCE) 7-10
- AISC Steel Construction Manual, 14th Edition
- Vulcraft deck catalog

Design Loads

Dead Loads

Dead loads were determined based on assumptions since no values were given on drawings except for weights of rooftop units which range from 8,000-45,000 lbs. Deck weight was compared to similar weights in Vulcraft catalog based on topping thickness and deck type. Roofing weights were based off in class examples. Façade weights was based off the weight of 4" brick.

| Dead Loads | |
|-------------------|------------|
| Description | Load (psf) |
| Framing | 10 |
| Superimposed DL | 10 |
| MEP | 5 |
| Composite Deck | |
| 3.25" LWC topping | 42 |
| 4.75" LWC topping | 50 |
| 5" NWC topping | 70 |
| Roof Garden | 80 |
| Partitions | 20 |
| Façade | |
| Brick | 40 |
| Glass | 10 |
| Metal Panel | 15 |

Live loads

Live load values were given on the drawings. These values can be shown along with the values given in ASCE7-10 in the table on the following page. Where values are not given in one source the value from the other source will be used in future calculations. Likewise, when differing values are present the larger of the two will be adopted in future calculations.

| Live Loads | | |
|-----------------------------|---------------------------------|---------------------|
| Description | Designed Load (psf) | ASCE7-10 Load (psf) |
| Slab on grade | 100 | N/A |
| Library slab on grade | 150 | 150 |
| Storage | 125 | 125 |
| Offices | 50 +20 (partition allowance) | 50 |
| Classrooms | 40 +20 (partition allowance) | 40 |
| Corridors (elevated floors) | 80 | 80 |
| Lobbies | 100 | 100 |
| Recreational areas | 100 | 100 |
| Mechanical/Electrical | 125 | N/A |
| Stairs | 100 | 100 |
| Chiller room | 150 + equipment | N/A |
| Boiler room | 200 + equipment | N/A |
| Roof | 30 | 20 |
| Roof Garden | N/A | 100 |

Snow Loads

With the use of flat roofs on 6 different levels the snow loading for the University Academic Center will prove to be an important consideration when designing the roof members. Both typical uniform snow loading and drifting have to be factored in.

Using ASCE7-10 to confirm the design loads used on the building were efficient, a flat roof snow load of 15.75 psf was calculated. According to the plans the building was designed for a snow load of 20 psf conservatively so.

Basic snow drift calculations were also done to find total snow load at 16 key locations of maximum drift as well as when $I_u = 20'$, the minimum length when accounting for drift is necessary as defined by 7.7.1.

Assumptions have been made based on presence of parapet walls along



all sides of all roofs that snow will not drift from one roof to another and only drift on lower level roofs against walls will need to be calculated. Because of presence of parapet walls, drift can be estimated for these based on drift heights found in calculations. Sample snow calculation can be found in the Appendix.

| Snow Drift Calculation | | | | | |
|------------------------|------------|------------|-------------|----------|-----------------|
| Location | I_u (ft) | h_d (ft) | p_d (psf) | w (ft) | p_{tot} (psf) |
| - | 20 | 1.00 | 17.32 | 4.02 | 33.07 |
| 1 | 100 | 2.52 | 43.40 | 10.06 | 59.15 |
| 2 | 62 | 1.98 | 34.15 | 7.92 | 49.90 |
| 3 | 90 | 2.39 | 41.23 | 9.56 | 56.98 |
| 4 | 61 | 1.96 | 33.86 | 7.85 | 49.61 |
| 5 | 80 | 2.25 | 38.90 | 9.02 | 54.65 |
| 6 | 46 | 1.69 | 29.08 | 6.74 | 44.83 |
| 7 | 109 | 2.62 | 45.23 | 10.49 | 60.98 |
| 8 | 94 | 2.44 | 42.12 | 9.77 | 57.87 |
| 9 | 109 | 2.62 | 45.23 | 10.49 | 60.98 |
| 10 | 103 | 2.55 | 44.02 | 10.21 | 59.77 |
| 11 | 118 | 2.72 | 46.96 | 10.89 | 62.71 |
| 12 | 116 | 2.70 | 46.59 | 10.80 | 62.34 |
| 13 | 101 | 2.53 | 43.61 | 10.11 | 59.36 |
| 14 | 33 | 1.39 | 24.00 | 5.56 | 39.75 |
| 15 | 63 | 2.00 | 34.44 | 7.98 | 50.19 |
| 16 | 49 | 1.75 | 30.11 | 6.98 | 45.86 |

Wind Loads

Wind loads were calculated using the Directional Procedure found in ASCE7-10 Chapter 27. Preliminary values taken from the drawings along with detailed calculations in determining wind loads and loading diagrams for wind forces can be found in the Appendix. An approximate building shape was taken for facilitating calculations based off the south and east elevations shown on the following page. This simplification still required the determining of wind pressures for three levels and roofs. A summary of wind analysis results can be seen below. Wind analysis concludes that the University Academic Center must be designed to resist an overturning moment of 87,357 kip-ft. This value surpasses that determined for seismic therefore wind controls the design of this building. This is logical given the relatively small seismic activity in the region.

| Wind Loads | | | | | | |
|------------|----------------|---------------------------|------------------|------------------|-------------|-----------------------------|
| Floor | Elevation (ft) | Total Wind Pressure (psf) | Façade Area (sf) | Wind Force (kip) | Shear (kip) | Overturning Moment (kip-ft) |
| Roof | 72 | 49.53 | 1574 | 78.0 | 100.9 | 7267.5 |
| 5 | 58 | 48.43 | 3652 | 176.9 | 317.5 | 18417.5 |
| 4 | 44 | 47.05 | 4566 | 214.8 | 544.0 | 23936.0 |
| 3 | 30 | 45.51 | 4976 | 226.5 | 758.8 | 22764.9 |
| 2 | 16 | 43.53 | 4976 | 216.6 | 935.7 | 14971.2 |
| Ground | 0 | 40.57 | 2488 | 100.9 | 1013.7 | 0.0 |
| Total | | | | 1013.7 | | 87357.2 |

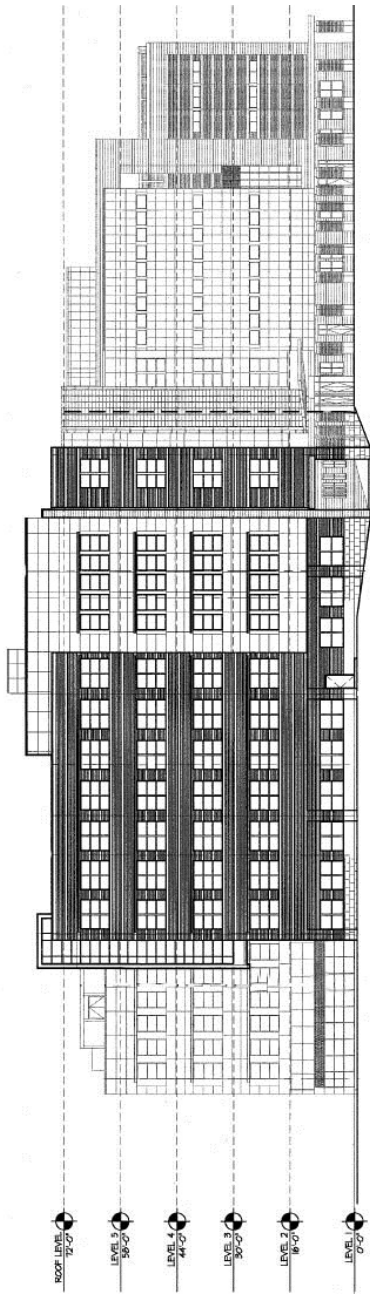

Drawings provided by Skanska

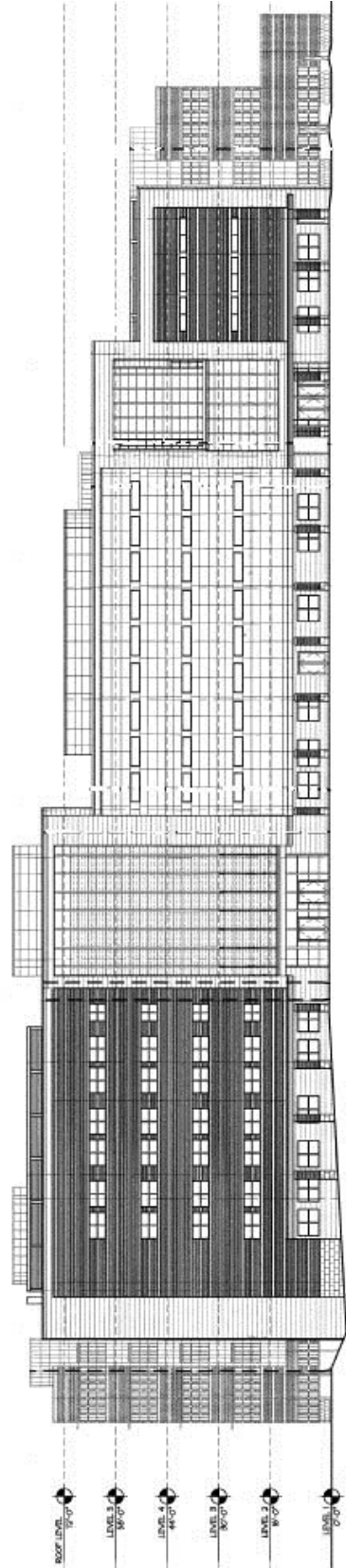

Drawings provided by Skanska

Beam Check

To keep consistent and minimize repeated calculations, one of the beams supporting the slab previously checked is also checked to verify size is sensible under designed loading. During check it was discovered beam is partially composite with shear strength controlling sizing. Knowing this a max moment was found using Table 3-19 in AISC manual. Beam size was also verified for live load deflection and unshored deflection. As designed the beam is capable of withstanding all these criteria as a W18x40.

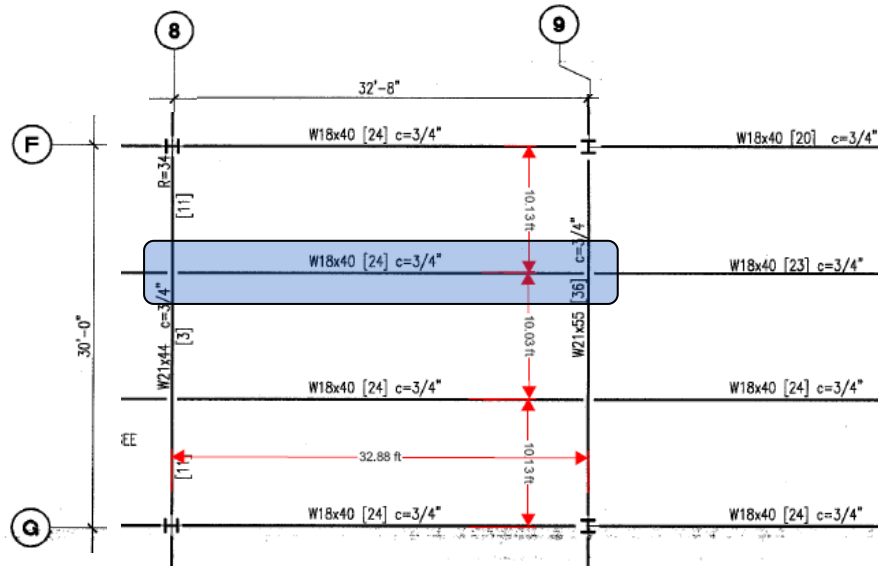

Drawings provided by Skanska

Column Check

As with the previous checks a member in close proximity was used to allow for reuse of calculated loading. The column in question is located at the intersection of gridlines G and 9 this column supports 3 classroom style floors and the chiller room on the roof. In calculating loading the weight of all floors as well as the rooftop units are included. Calculations show the W12x87 column is sufficient to support the gravity loads after employing live load reduction. Appendix contains diagram of column in question and hand calculations.

Conclusion

This report was designed to gain a better understanding of the University Academic Center and the design of its structural systems. Specifically through the analysis of gravity and lateral systems under dead, live, snow, wind, and seismic loading. More close calculations were done to verify sizing of several framing members as well. The initial findings in this report will provide a solid foundation for future exploration into the structure. Comparing code and standards to applied practice is an important first step to making educated decisions when designing new systems in future reports.

Appendix

- ◆ **Snow Loads (24)**
- ◆ **Seismic Loads (25-28)**
- ◆ **Wind Loads (29-33)**
- ◆ **Spot Checks (34-37)**

| | | | |
|---|-----------|--------|--------------------|
| 1 | AÉ Thesis | Tech 1 | Alexander Altemose |
|---|-----------|--------|--------------------|

Snow Load

Flat Roof Snow Load, P_f

$$P_f = 0.7 C_e C_t I_s P_g$$

$$P_g = 25 \text{ psf} \quad (\text{Fig. 7-1})$$

$$C_e = 0.9 \quad (\text{Table 7-2})$$

$$C_t = 1.0 \quad (\text{Table 7-3})$$

$$I_s = 1.0 \quad (\text{Table 1.5-2})$$

$$P_f = 0.7(0.9)(1.0)(1.0)(25)$$

$$P_f = 15.75 \text{ psf} \quad (\text{Calculated})$$

$$P_f = 20 \text{ psf} \quad (\text{As Designed})$$

Snow Drift

$$\gamma = 0.13 P_g + 14 = 17.25 \text{ pcf}$$

$$h_b = \frac{P_s}{\gamma} = \frac{15.75}{17.25} = 0.91' > 0.2$$

∴ calculate drift

→ Sample Calc for Snow drift

Location 1

$$l_u = 100'$$

$$h_d = 0.43 \sqrt[3]{l_u} \sqrt[4]{P_g + 10} - 1.5 = 2.52'$$

\uparrow 100' \uparrow 25 psf

$$P_d = h_d \gamma = 2.52' (17.25 \text{ pcf}) = 43.47 \text{ psf}$$

$$P_{tot} = P_f + P_d = 15.75 + 43.47 = 59.22 \text{ psf}$$

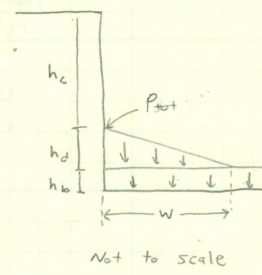
$$h_c \sim 42' > h_d \rightarrow w = 4h_d = 10.08'$$

| | | | |
|--|-----------|--------|--------------------|
| 2 | AF Thesis | Tech 1 | Alexander Altemose |
| <p><u>Seismic Load</u></p> <p><u>Data Given in Drawings</u></p> <p>seismic use group: 1</p> <p>$S_{Ds} : 0.21$ $S_{D1} : 0.11$</p> <p>site class: D</p> <p>seismic-force-resisting system: ^{special steel} concentrically braced frames</p> <p>design base shear (V): 363 kips</p> <p>analysis procedure: equivalent lateral force method</p> <p><u>Equivalent Lateral Force Procedure (per ASCE 7-10)</u></p> <p>$V = C_s W$ (12.8-1)</p> <p>$C_s = \frac{S_{Ds}}{\left(\frac{R}{I_e}\right)}$ (12.8-2)</p> <p>$I_e = 1.0$ (Table 1.5-2)</p> <p>$R = 6$ (Table 12.2-1)</p> <p>$S_{Ds} = \frac{2}{3} S_{ms}$ (11.4-3)</p> <p>$S_{ms} = F_a S_s$ (11.4-1)</p> <p>$S_s = 0.12$ (Fig 22-1)</p> <p>$F_a = 1.6$ (Table 11.4-1)</p> <p>↳ $S_{ms} = 0.192$</p> <p>↳ $S_{Ds} = 0.128$</p> <p>↳ $C_s = 0.021$</p> | | | |

| | | | |
|---|-----------|--------|--------------------|
| 3 | AE Thesis | Tech 1 | Alexander Altemose |
| <p style="text-align: center;"><u>Seismic (cont'd)</u></p> $C_s \leq C_s^* = \frac{S_{D1}}{T \left(\frac{R}{I_e} \right)} \quad \text{for } T \leq T_L \quad (12.8-3)$ $T \cong T_a = C_t h_n^x \quad (12.8-7)$ $h_n = 72'$ $C_t = 0.02 \quad (\text{Table 12.8-2})$ $x = 0.75 \quad (\text{Table 12.8-2})$ <p style="text-align: center;">$\hookrightarrow T = T_a = 0.494_s$</p> $T_L = 8_s \quad (\text{Figure 12-12})$ $S_{D1} = \frac{2}{3} S_{m1} \quad (11.4-4)$ $S_{m1} = F_v S_i \quad (11.4-2)$ $S_i = 0.05 \quad (\text{Figure 22-2})$ $F_v = 2.4 \quad (\text{Table 11.4-2})$ <p style="text-align: center;">$\hookrightarrow S_{m1} = 0.12$</p> <p style="text-align: center;">$\hookrightarrow S_{D1} = 0.08$</p> <p style="text-align: center;">$\hookrightarrow C_s^* = 0.027 > C_s = 0.021 \quad \checkmark_{ok}$</p> $C_s = 0.044 S_{D1} I_e \geq 0.01 \quad (12.8-5)$ $C_s = 0.021 > 0.01 \quad \checkmark_{ok}$ | | | |

| 4 | Tech 1 | AE Thesis | Alexander Altemose |
|---|--------|-----------|--------------------|
| <u>Seismic (cont'd)</u> | | | |
| <u>Calculation of building weight (W)</u> | | | |
| Level 1 : $W = 55,000 \text{ sf } (5") (150 \text{ pcf}) \text{ slab on grade} \approx 3,618 \text{ kip}$ $1,130' (16') (20 \text{ psf}) \frac{1}{2} \text{ facade}$ | | | |
| Level 2 : $W = 7,000 \text{ sf } (80 \text{ psf}) \text{ green roof}$ $7,000 \text{ sf } (40 \text{ psf}) \text{ typ. roof}$ $41,000 \text{ sf } (42 + 10 + 5 + 10) \text{ psf floor} \approx 3,953 \text{ kip}$ $1,130' (16') (20 \text{ psf}) \frac{1}{2}$ $1,320' (14') (20 \text{ psf}) \frac{1}{2} \text{ facade}$ | | | |
| Level 3 : $W = 1,900 \text{ sf } (80 \text{ psf}) \text{ green roof}$ $41,000 \text{ sf } (42 + 10 + 5 + 10) \text{ psf floor} \approx 3,269 \text{ kip}$ $1,320' (14') (20 \text{ psf}) \text{ facade}$ | | | |
| Level 4 : $W = 5,700 \text{ sf } (40 \text{ psf}) \text{ typ roof}$ $35,300 \text{ sf } (42 + 10 + 5 + 10) \text{ psf floor} \approx 2,966 \text{ kip}$ $1,320' (14') (20 \text{ psf}) \frac{1}{2}$ $1,180' (14') (20 \text{ psf}) \frac{1}{2} \text{ facade}$ $(8,000 + 15,000) \text{ roof units}$ | | | |
| Level 5 : $W = 19,300 \text{ sf } (70 \text{ psf}) \text{ roof}$ $16,000 \text{ sf } (42 + 10 + 5 + 10) \text{ psf floor} \approx 2,995 \text{ kip}$ $1,180' (14') (20 \text{ psf}) \frac{1}{2}$ $1,000' (14') (20 \text{ psf}) \frac{1}{2} \text{ facade}$ $16,000(2) + 25,000 + 40,000(3) + 45,000(2) \text{ roof units}$ | | | |
| Level 6 : $W = 14,000 \text{ sf } (50 \text{ psf}) \text{ roof}$ $2,000 \text{ sf } (42 + 10 + 5 + 10) \text{ psf floor} \approx 1,084 \text{ kip}$ $1,000' (14') (20 \text{ psf}) \frac{1}{2}$ $200' (12') (20 \text{ psf}) \frac{1}{2} \text{ facade}$ $18,000(2) + 25,000(2) \text{ roof units}$ | | | |
| Roof : $W = 2,000 \text{ sf } (40 \text{ psf}) \text{ typ. roof} \approx 104 \text{ kip}$ $200' (12') (20 \text{ psf}) \frac{1}{2} \text{ facade}$ | | | |
| Total : $W = 17,989 \text{ kip}$ | | | |
| Base Shear : $V = C_s W = 0.021(17,989) = 377 \text{ kip}$ | | | |

5

Tech 1

AE Thesis

Alexander Altemose

Seismic (cont'd)

Seismic Loading Diagram (Not drawn to scale)

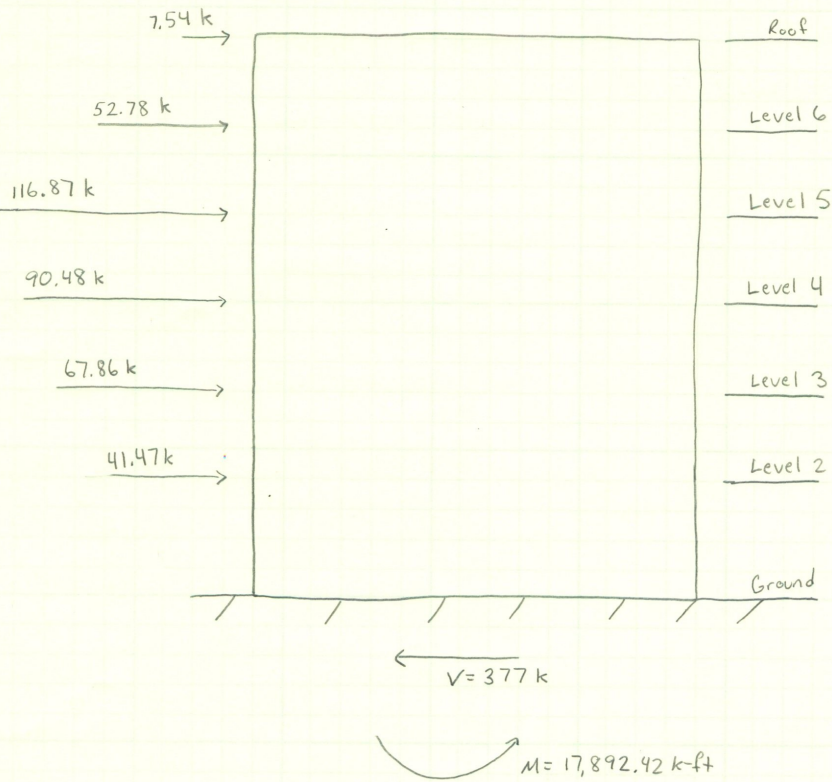

| 6 | Tech 1 | AE Thesis | Alexander Altemose |
|--|--------|-----------|--------------------|
| <p>Wind Loads → MWFRS (Directional Procedure) [Steps outlined in Table 27.2-1] Analysis will be used</p> <p>Values given on drawings</p> <p>basic wind speed (V) = 90 MPH wind load importance factor (I_w) = 1.15 risk category II wind exposure C internal pressure coefficient = 0.18</p> <p>[Values are base on and older version of ASCE standard Calculations are based off current version ASCE7-10 Values will differ from design]</p> <p>Basic Wind Parameters:</p> <p>[Step 1] Risk Category II [Step 2] $V = 115$ MPH [Step 3] $K_d = 0.85$ Exposure C $K_{zt} = 1$ [Assumed based on lack of topographic concern on site] $G = 0.85$ Enclosure = Fully Enclosed $G C_{pi} = \pm 0.18$</p> | | | |

| | | | |
|---|--------|-----------|--------------------|
| 7 | Tech 1 | AE Thesis | Alexander Altemose |
|---|--------|-----------|--------------------|

Wind (cont'd)

$G = 0.85$ if rigid or $G = 0.925 \left(\frac{1 + 1.7 q_a I_z Q}{1 + 1.7 q_v I_z} \right)$ (26.9-6)

Determination if rigid:

$h < 300'$ ✓

$h < 4 L_{eff} \rightarrow L_{eff} = \frac{\sum h_i L_i}{\sum h_i}$

$h < 216.7(4)$

$72' < 866.8'$ ✓ $\rightarrow n_a$ can be used

N-S

$$L_{eff} = \frac{174'(72') + 237'(58') + 260'(44')}{72' + 58' + 44'} = 216.7'$$

E-W

$$L_{eff} = \frac{233'(72') + 293'(58') + 362'(44') + 382'(16')}{72' + 58' + 44' + 16'} = 293.7'$$

$n_a = 22.2/h^{0.8} = 22.2/50^{0.8} = 1.0 \rightarrow$ Rigid Building $\rightarrow G = 0.85$

$\min \left\{ \begin{array}{l} n_a = 75/h = 75/50 = 1.5 \end{array} \right.$

| [Step 4] K_z | Roof heights (ft) | q_z (psf) | Roof heights (ft) |
|----------------|-------------------|---------------|-------------------|
| 0.86 | 16 | 24.75 | 16 |
| 0.98 | 30 | 28.20 | 30 |
| 1.06 | 44 | 30.50 | 44 |
| 1.122 | 58 | 32.29 | 58 |
| 1.178 | 72 | 33.90 | 72 |
| 1.222 | 84 | 35.17 | 84 |
| $K_h = 1.09$ | $h = 50$ | $q_h = 31.86$ | 50 |

[Step 5] $q_z = 0.00256 K_z K_{zt} K_d V^2$ (psf) (27.3-1)

| | | | |
|---|--------|-----------|--------------------|
| 8 | Tech 1 | AE Thesis | Alexander Altemose |
|---|--------|-----------|--------------------|

Wind (cont'd)

[Assumed shape of building based off elevations]

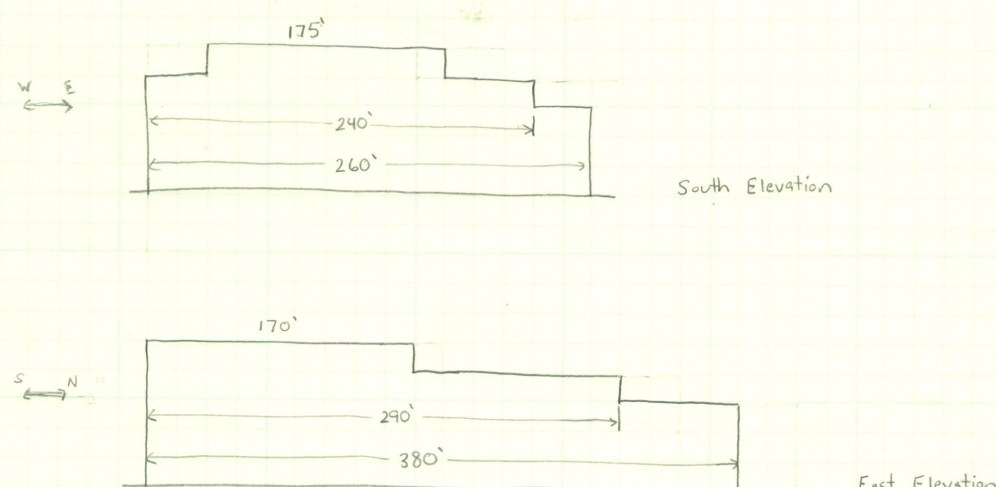

[Step 6] (Figure 27.4-1)

[Step 7]

$$p = qGC_p - q_i(GC_{pi}) \text{ (psf)} \quad (27.4-1)$$

Sample Calc:

| | |
|-----------------------------------|---|
| N-S Windward Ground level | $p = 24.75(0.85)(0.8) - 24.75(-0.18) = 21.285 \text{ psf}$ |
| N-S Leeward 5-story section | $p = 31.86(0.85)(-0.5) - 31.86(+0.18) = -19.28 \text{ psf}$ |
| N-S Upper Roof 0-36' | $p = 31.86(0.85)(-0.9) - 31.86(+0.18) = -30.11 \text{ psf}$ |

| Wind Pressures (E-W) | | | | | | |
|----------------------|---------|----------|-------|-------|-------|--------|
| Location | Level | Distance | Kz | qz | qh | p |
| Windward | Ground | 0 | 0.86 | 24.75 | 31.86 | 21.29 |
| | 2 | 16 | 0.98 | 28.2 | 31.86 | 24.25 |
| | 3 | 30 | 1.06 | 30.5 | 31.86 | 26.23 |
| | 4 | 44 | 1.122 | 32.29 | 31.86 | 27.77 |
| | 5 | 58 | 1.178 | 33.9 | 31.86 | 29.15 |
| | Roof | 72 | 1.222 | 35.17 | 31.86 | 30.25 |
| Leeward | 5-story | 0-72 | 1.222 | 35.17 | 31.86 | -19.28 |
| | 4-story | 0-58 | 1.222 | 35.17 | 31.86 | -19.28 |
| | 3-story | 0-44 | 1.222 | 35.17 | 31.86 | -19.28 |
| Side | | 0-72 | 1.222 | 35.17 | 31.86 | -24.69 |
| Roof | Upper | 0-36 | 1.222 | 35.17 | 31.86 | -30.11 |
| | | 36-72 | 1.222 | 35.17 | 31.86 | -30.11 |
| | | 72-144 | 1.222 | 35.17 | 31.86 | -19.28 |
| | | >144 | 1.222 | 35.17 | 31.86 | -19.28 |
| | Mid | 0-29 | 1.178 | 33.9 | 31.86 | -30.11 |
| | | 29-58 | 1.178 | 33.9 | 31.86 | -19.28 |
| | | >116 | 1.178 | 33.9 | 31.86 | -13.86 |
| | | Lower | >88 | 1.122 | 32.29 | 31.86 |

| Wind Pressures (N-S) | | | | | | |
|----------------------|---------|----------|-------|-------|-------|--------|
| Location | Level | Distance | Kz | qz | qh | p |
| Windward | Ground | 0 | 0.86 | 24.75 | 31.86 | 21.29 |
| | 2 | 16 | 0.98 | 28.2 | 31.86 | 24.25 |
| | 3 | 30 | 1.06 | 30.5 | 31.86 | 26.23 |
| | 4 | 44 | 1.122 | 32.29 | 31.86 | 27.77 |
| | 5 | 58 | 1.178 | 33.9 | 31.86 | 29.15 |
| | Roof | 72 | 1.222 | 35.17 | 31.86 | 30.25 |
| Leeward | 5-story | 0-72 | 1.222 | 35.17 | 31.86 | -19.28 |
| | 4-story | 0-58 | 1.222 | 35.17 | 31.86 | -18.19 |
| | 3-story | 0-44 | 1.222 | 35.17 | 31.86 | -16.84 |
| Side | | 0-72 | 1.222 | 35.17 | 31.86 | -24.69 |
| Roof | Upper | 0-36 | 1.222 | 35.17 | 31.86 | -30.11 |
| | | 36-72 | 1.222 | 35.17 | 31.86 | -30.11 |
| | | 72-144 | 1.222 | 35.17 | 31.86 | -19.28 |
| | | >144 | 1.222 | 35.17 | 31.86 | -19.28 |
| | Mid | 0-29 | 1.178 | 33.9 | 31.86 | -30.11 |
| | | 29-58 | 1.178 | 33.9 | 31.86 | -19.28 |
| | | >116 | 1.178 | 33.9 | 31.86 | -13.86 |
| | | Lower | >88 | 1.122 | 32.29 | 31.86 |

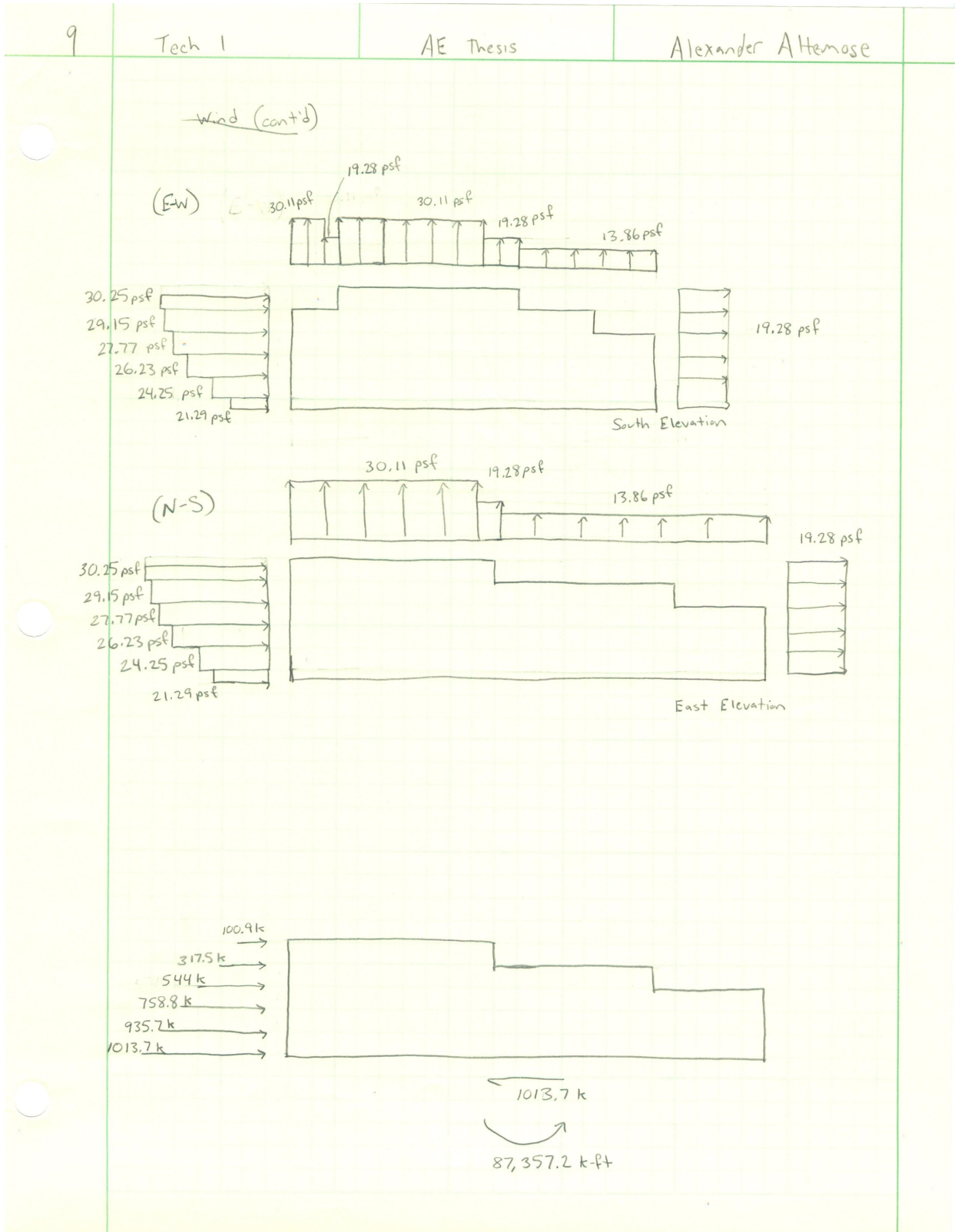

| | | | | | | | | | | | | | | | | | | |
|---|--------|-----------------|--------------------|----|--------|---------|--|--------|-----------------|--|-------|-----|--|--------|------------|----|--------|-----------|
| 10 | Tech 1 | AE Thesis | Alexander Altemose | | | | | | | | | | | | | | | |
| <p><u>Spot Checks</u></p> | | | | | | | | | | | | | | | | | | |
| <p><u>Slab check</u></p> | | | | | | | | | | | | | | | | | | |
| <p><u>Loads:</u></p> | | | | | | | | | | | | | | | | | | |
| <table border="0"> <tr> <td>DL</td> <td>10 psf</td> <td>framing</td> </tr> <tr> <td></td> <td>10 psf</td> <td>superimposed DL</td> </tr> <tr> <td></td> <td>5 psf</td> <td>MEP</td> </tr> <tr> <td></td> <td>20 psf</td> <td>Partitions</td> </tr> <tr> <td>LL</td> <td>40 psf</td> <td>Classroom</td> </tr> </table> | | | | DL | 10 psf | framing | | 10 psf | superimposed DL | | 5 psf | MEP | | 20 psf | Partitions | LL | 40 psf | Classroom |
| DL | 10 psf | framing | | | | | | | | | | | | | | | | |
| | 10 psf | superimposed DL | | | | | | | | | | | | | | | | |
| | 5 psf | MEP | | | | | | | | | | | | | | | | |
| | 20 psf | Partitions | | | | | | | | | | | | | | | | |
| LL | 40 psf | Classroom | | | | | | | | | | | | | | | | |
| <ul style="list-style-type: none"> - 3 1/4" LWC topping - 2" 18 gage deck - 5 1/4" total thickness - 10' span - 40 psf LL | | | | | | | | | | | | | | | | | | |
| <p>Using Vulcraft Catalog → 2VLI18 deck 42 psf</p> <ul style="list-style-type: none"> - 3 1/4" LWC ✓ - 2" 18 gage ✓ - 5 1/4" thick ✓ - 12'-7" Max 3 span > 10' ✓ - LL at 10' = 205 psf > 40 psf ✓ | | | | | | | | | | | | | | | | | | |
| <p style="text-align: center;">2VLI18 deck OK to use</p> | | | | | | | | | | | | | | | | | | |

| | | | |
|---|--------|--|--------------------|
| 11 | Tech 1 | AE Thesis | Alexander Altemose |
| <u>Spot Checks (contd)</u> | | | |
| <u>Beam Check</u> | | Given: W18x40 [24] shear studs (as per design) | |
| <u>Loads:</u> slab/deck 42 psf superimposed DL 10 psf MEP 5 psf self-wt 5 psf Partitions 20 psf LL 40 psf | | $I_x = 612 \text{ in}^4$ $A_s = 11.8 \text{ in}^2$ $f_y = 50 \text{ ksi}$ $f'_c = 3000 \text{ psi}$ $I_{LB} = 1600 \text{ in}^4$ | |
| <u>LL Reduction</u> | | | |
| $A_T = 10'(32.67') = 326.7 \text{ ft}^2$ | | | |
| $K_{LL} = 2 \quad \rightarrow \quad 653.4 \text{ ft}^2 > 400 \text{ ft}^2 \quad \text{Reduce}$ | | | |
| $L = 40 \left(0.25 + \frac{15}{\sqrt{653.4}} \right) = 33.47 \approx 33.5 \text{ psf}$ | | | |
| $w_u = 1.2(82) + 1.6(33.5) = 152$ | | | |
| $w_u = 152(10') = 1.52 \text{ k/ft}$ | | | |
| $M_u = \frac{w_u l^2}{8} = \frac{1.52(32.67)^2}{8} = 202.8 \text{ k-ft}$ | | | |
| $V_u = \frac{w_u l}{2} = \frac{1.52(32.67)}{2} = 24.8 \text{ k}$ | | | |
| Deck L, weak studs, 1, $\frac{3}{4} \phi$ (assumed from plans) | | | |
| $Q_n = 17.2 \text{ k}$ (Table 3-21) | | | |
| $\phi Q_n = 24(17.2) = 464.4 \text{ k}$ | | | |

| 12 | Tech 1 | AE Thesis | Alexander Altemose |
|---|--------|-----------|--------------------|
| <u>Spot checks (cont'd)</u> | | | |
| <u>Beam check (cont'd)</u> | | | |
| $b_{eff} = \min \left\{ \begin{array}{l} \text{span} = \frac{32.67}{4} \cong 8' \leftarrow \text{controls} \\ \text{spacing} = 10' \end{array} \right.$ | | | |
| <u>PNA Location:</u> | | | |
| $V_c = 0.85 (f_c) (b_{eff}) (t) = 0.85 (3000) (8') (12) (3.25') = 795.6 \text{ k}$ | | | |
| $V_s = A_s f_y = 11.8 (50) = 590 \text{ k}$ | | | |
| $V_q = \Sigma Q_n = 464.4 \text{ k} \quad \therefore \text{partially composite}$ | | | |
| $a = \frac{464.4}{0.85 (3) (96'')} = 1.9'' \quad Y_2 = 5.25 - \frac{1.9}{2} = 4.3 \leftarrow \text{Use } 4'' \text{ for conservative}$ | | | |
| <p>Using Table 3-19 \downarrow</p> $\phi M_n = 573 \text{ k-ft} > M_u = 202.8 \text{ k-ft} \quad \checkmark \text{ OK}$ | | | |
| <u>Δ check</u> | | | |
| $\Delta_{LL} = \frac{5 w L^4}{384 E I} = \frac{5 (10)(40) (32.67)^4 (1728)}{1000 (384) (29000) (1600)} = 0.22 \text{ in}$ | | | |
| $\Delta_{LL} < \frac{L}{360} = \frac{32.67(12)}{360} = 1.09 \text{ in} > 0.22 \text{ in} \quad \checkmark \text{ OK}$ | | | |
| $A_{wc} = \frac{5 w_{wc} (32.67)^4 (1728)}{384 (29000) 612} \Rightarrow w_{wc} = 42 (10') + 40 = 0.46 \text{ k/ft}$ | | | |
| $\Delta_{wc} = 0.66 \text{ in}$ | | | |
| $\Delta_{wc} = \frac{32.67(12)}{240} = 1.63 \text{ in} > 0.66 \text{ in} \quad \checkmark \text{ OK}$ | | | |
| <p>W18x40 [24] is OK</p> | | | |

| | | | |
|--|--------|-----------|--------------------|
| 13 | Tech 1 | AE Thesis | Alexander Altemose |
| <p style="text-align: center;"><u>Spot check (cont'd)</u></p> <p style="text-align: center;"><u>Column Check</u></p> <p style="text-align: center;">Interior column Ground floor W12x87</p> <div style="display: flex; justify-content: space-between;"> <div data-bbox="324 525 779 903"> <p>The diagram shows a vertical column section with floor levels marked by horizontal lines. The column is labeled 'W12x87'. Areas above and below the column are labeled 'A+' and 'Ai' respectively. A circled 'G' is on the left, and a circled 'C' is at the top of the column.</p> </div> <div data-bbox="860 567 1201 882"> <p>$A_+ = 30(30.67) = 920.1 \text{ ft}^2$</p> <p>$A_i = 61.34(60) = 3680.4 \text{ ft}^2$</p> <p>SL = 20 psf * assumed no drift</p> <p>LL = 150 psf (chiller room) + 40 psf (3)</p> <p>LL = 270 psf (920.1) = 248.4 kip</p> </div> </div> <p style="margin-top: 20px;"><u>LL Reduction</u></p> <p>$L = 40 \left(0.25 + \frac{15}{3680} \right) \approx 20 \text{ psf}$</p> <p style="margin-top: 20px;">$\Delta L + \text{Col Wt} = \Delta L$</p> <p>$382.3 + \frac{33(87)}{1000} + \frac{25(65)}{1000} = 387 \text{ kip}$</p> <p style="margin-top: 20px;">$1.2(387) + 1.6(193.2) + 20(05) = 784 \text{ k}$</p> <p style="margin-top: 20px;">At KL = 16', $\phi P_n = 865 \text{ k} > 784 \text{ k}$ ✓ ok.</p> <div style="border: 1px solid black; padding: 5px; width: fit-content; margin: 20px auto;"> <p>USE W12x87</p> </div> | | | |